

tBOX322-882-FL

Fanless Embedded System with 4th Gen Intel® Core™ Processor for Railway PC

Features

- EN 50155 and EN 50121 certified
- Fanless design and wide temperature range from -40°C to +70°C (EN 50155 class TX)
- Comply to fire protection of railway vehicles Europe standard PrCEN TS 45545-2
- 4th gen Intel® Core™ i7 or Core™ i3 processor
- DDR3L-1600 4GB or 8GB onboard
- Isolated RS-232/422/485 and DIO
- USB 3.0 and SATA 3
- 1 removable & lockable 2.5" SATA HDD and 1 CFast™/mSATA
- 3 internal PCIe Mini Card slot and 2 SIM slots
- Lockable M12 LAN, audio, power and USB connectors
- Suspension designed for HDD

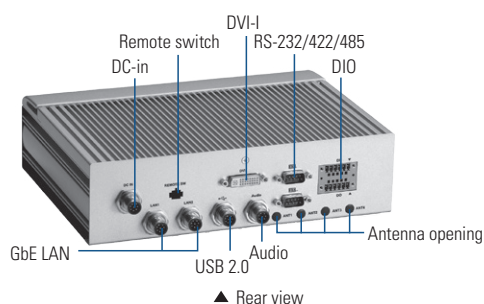
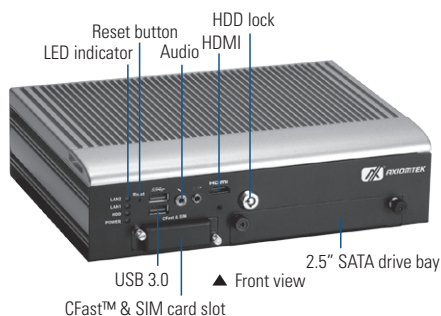

Specifications

Standard Color	Silver-Black				
Construction	Aluminum extrusion and heavy-duty steel, IP40				
CPU	Intel® Core™ i7-4650U (1.7 GHz up to 3.3 GHz) or Intel® Core™ i3-4010U (1.7 GHz)				
System Memory	DDR3L-1600 4GB or 8GB DRAM				
Chipset	SoC integrated				
BIOS	AMI UEFI BIOS with OA 3.0 built				
System I/O Outlet	<table border="0"> <tr> <td>Rear Side</td> <td> <ul style="list-style-type: none"> 2 x GbE LAN (M12 A-coded) 2 x Isolated RS-232/422/485 1 x Isolated DI/DO (6-in/2-out) 1 x USB 2.0 (M12 A-coded) 1 x Audio (mic-in/line-out, M12 D-coded) 1 x DVI-I 1 x VDC power input (M12 A-coded) 1 x Remote power switch 4 x Antenna opening 1 x Power switch </td> </tr> <tr> <td>Front Side</td> <td> <ul style="list-style-type: none"> 2 x USB 3.0 2 x Audio (mic-in/line-out, screw type) 1 x HDMI 1 x Reset switch 1 x 2.5" SATA drive tray 1 x CFast™ slot + 2 x SIM card sockets </td> </tr> </table>	Rear Side	<ul style="list-style-type: none"> 2 x GbE LAN (M12 A-coded) 2 x Isolated RS-232/422/485 1 x Isolated DI/DO (6-in/2-out) 1 x USB 2.0 (M12 A-coded) 1 x Audio (mic-in/line-out, M12 D-coded) 1 x DVI-I 1 x VDC power input (M12 A-coded) 1 x Remote power switch 4 x Antenna opening 1 x Power switch 	Front Side	<ul style="list-style-type: none"> 2 x USB 3.0 2 x Audio (mic-in/line-out, screw type) 1 x HDMI 1 x Reset switch 1 x 2.5" SATA drive tray 1 x CFast™ slot + 2 x SIM card sockets
Rear Side	<ul style="list-style-type: none"> 2 x GbE LAN (M12 A-coded) 2 x Isolated RS-232/422/485 1 x Isolated DI/DO (6-in/2-out) 1 x USB 2.0 (M12 A-coded) 1 x Audio (mic-in/line-out, M12 D-coded) 1 x DVI-I 1 x VDC power input (M12 A-coded) 1 x Remote power switch 4 x Antenna opening 1 x Power switch 				
Front Side	<ul style="list-style-type: none"> 2 x USB 3.0 2 x Audio (mic-in/line-out, screw type) 1 x HDMI 1 x Reset switch 1 x 2.5" SATA drive tray 1 x CFast™ slot + 2 x SIM card sockets 				
Watchdog Timer	255 levels, 0 ~ 255 sec./min.				
Storage	1 x 2.5" SATA HDD (Removable and with lock protection) 1 x CFast™/ 1 x mSATA				
Expansion Interface	3 x PCIe Mini Card slot 2 x SIM card slot				
System Indicator	1 x green LED for system power on 1 x green LED for HDD active 1 x green LED for LAN1 link 1 x green LED for LAN2 link				
Power Supply	Power input: 14 VDC ~ 32 VDC (isolation) Typical: 24 VDC				
Power Consumption	1.8A @ 24V				
Operating Temperature	-40°C ~ +70°C (-40°F ~ +158°F) with W.T. SSD -25°C ~ +55°C (-13°F ~ +131°F) with W.T. HDD				
Humidity	5% ~ 95%, non-condensing				

Vibration Endurance	3 Grms with SSD or CFast™ (5 ~ 500Hz, X, Y, Z directions) 2 Grms with HDD (5 ~ 500Hz, X, Y, Z directions)
Dimensions	244 mm (9.6") (W) x 180.5 mm (7.1") (D) x 65.1 mm (2.56") (H)
Weight (net/gross)	2.94 kg (6.48 lb)/ 3.94 kg (8.68 lb)
Certificate	CE (Class A), EN 50155, EN 50121, EN 45545-2, EN 60950-1 compliance
EOS Support	WE8S, WES 7, Linux

Ordering Information

Standard	
tBOX322-882-FL-i7-DC (P/N: E26N322100)	Fanless railway embedded system with Intel® Core™ i7-4650U, 4GB DDR3L, 2 GbE LANs (M12), 2 isolated COM and CFast™
tBOX322-882-FL-i3-DC (P/N: E26N322101)	Fanless railway embedded system with Intel® Core™ i3-4010U, 4GB DDR3L, 2 GbE LANs (M12), 2 isolated COM and CFast™
tBOX322-882-FL-8GB-i7-DC (P/N: E26N322102)	Fanless railway embedded system with Intel® Core™ i7-4650U, 8GB DDR3L, 2 GbE LANs (M12), 2 isolated COM and CFast™
tBOX322-882-FL-8GB-i3-DC (P/N: E26N322103)	Fanless railway embedded system with Intel® Core™ i3-4010U, 8GB DDR3L, 2 GbE LANs (M12), 2 isolated COM and CFast™
Optional	
2.5" SATA HDD/SSD	16GB or above
CFast™	1GB or above
3G module	
Wi-Fi module	
Wi-Fi Bluetooth	
GPS module	
M12 Gigabit LAN cable	
M12 power cable	
M12 USB cable	
M12 audio cable	
Remote switch cable	

*Specifications and certifications may vary according to various options.

Expansion & Installation

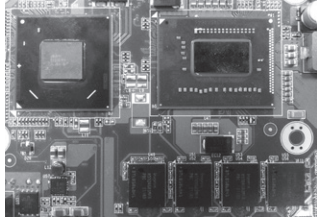

Onboard 4th generation Intel® Core™ CPU and 4GB/ 8GB DDR3L DRAM



Swappable and lockable SATA3 HDD/SSD, Audio jack, USB 3.0 and CFast™

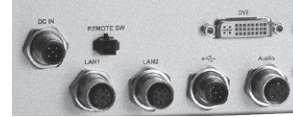

M12 type for Gigabit LAN, USB 2.0 and audio ports

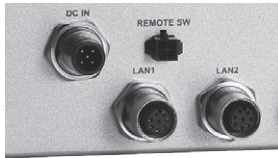

M12 type power connector and remote switch connector

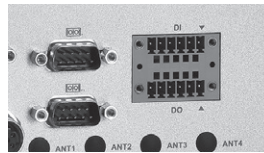

Isolated RS-232/422/485 and DIO ports

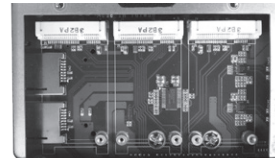

3 PCIe Mini Card slots and 2 SIM slots

Packing List

- 1 x Quick manual
- 1 x Driver CD
- 1 x Screw pack
- 4 x Foot pad
- 1 x Wall-mount kit

Power Protection

DC Version

- SCP (short circuit protection)
- OVP (over voltage protection)
- UVP (under voltage protection)

Dimensions

